



LYON[®] SHELVING
PRODUCTS

Maximize Your Storage Space

SHELVING UNITS

Pre-engineered sections are 36", 42", and 48" wide and 84", 96" and 120" high, with shelves adjustable on 1-1/2" centers. For double row, back-to-back installations, use economical open back shelving on one side, common backs of closed shelving sections on the other side. Some assembly required.



SHELF OPTIONS

Capacities ranging from 300 lbs to 1,300 lbs. See shelf load capacities on page 3.

Patented Box "W" design provides added support to the front and rear of the shelf. Lapped and welded shelf corners provide added strength and durability.

Available in 22-Gauge Medium-Duty Box "W", 20-Gauge Heavy-Duty Box "W", 18-Gauge Extra Heavy-Duty Box "W" and 18-Gauge Traditional Flanged.

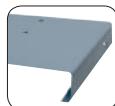

SHELVING LOAD CAPACITIES

Shelving capacities are based on evenly distributed loads. All shelves maintain a 1.65 safety factor and posts a 1.92 factor. Maximum load capacity per section is 8,000 lbs. based on 18" maximum shelf spacing and no seismic considerations.

Size W x D	22-Ga. Medium Box "W"		20-Ga. Heavy Duty Box "W"		18-Ga. Extra Heavy Duty Box "W"		18-Ga. Traditional Flanged	
	Cat. No.	Capacity	Cat. No.	Capacity	Cat. No.	Capacity	Cat. No.	Capacity
30" x 30"	N/A	N/A	8593H	800 lbs.	N/A	N/A	N/A	N/A
36" x 12"	8560M	600 lbs.	8560H	800 lbs.	8560X	1,150 lbs.	8560	550 lbs.
36" x 15"	8584M	600 lbs.	8584H	825 lbs.	8584X	1,200 lbs.	8584	600 lbs.
36" x 18"	8561M	600 lbs.	8561H	900 lbs.	8561X	1,300 lbs.	8561	650 lbs.
36" x 24"	8562M	600 lbs.	8562H	800 lbs.	8562X	1,150 lbs.	8562	700 lbs.
36" x 30"	**	**	8585H	740 lbs.	8585X	950 lbs.	8585	500 lbs.
36" x 36"	**	**	8586H	640 lbs.	8586X	850 lbs.	8586	450 lbs.
42" x 12"	**	**	8565H	650 lbs.	8565X	830 lbs.	8565	500 lbs.
42" x 15"	**	**	8587H	650 lbs.	8587X	880 lbs.	8587	475 lbs.
42" x 18"	**	**	8566H	720 lbs.	8566X	900 lbs.	8566	450 lbs.
42" x 24"	**	**	8567H	700 lbs.	8567X	880 lbs.	8567	500 lbs.
42" x 30"	**	**	8588H	650 lbs.	8588X	850 lbs.	8588	400 lbs.
42" x 36"	**	**	8589H	625 lbs.	8589X	820 lbs.	8589	325 lbs.
48" x 12"	**	**	8300H	600 lbs.	8300X	750 lbs.	8300	350 lbs.
48" x 15"	**	**	8590H	600 lbs.	8590X	700 lbs.	8590	325 lbs.
48" x 18"	**	**	8301H	600 lbs.	8301X	700 lbs.	8301	300 lbs.
48" x 24"	**	**	8302H	560 lbs.	8302X	750 lbs.	8302	300 lbs.
48" x 30"	**	**	8591H	540 lbs.	8591X	730 lbs.	8591	300 lbs.
48" x 36"	**	**	8592H	480 lbs.	8592X	640 lbs.	8592	300 lbs.

**Please consult your factory representative, Lyon does not generally recommend 22-gauge on industrial shelving requirements larger than 36" x 24"

T-Post Uprights

Patented design, formed of tough, durable, hot rolled steel affords easy shelf adjustment on 1-1/2" centers using shelf clips. High strength T-Posts available.

Shelf Clips

All shelving units come with 4 shelving clips per shelf.

Quickly lock into place, on either side of uprights. Disengages easily to re-position shelves, no tools needed.

Down Aisle Growth Chart

T-Post: 1-1/2" over-all, over the whole run of shelving not per bay

Offset Angle: 7/16" over-all, growth is per bay

Depth Growth: 9/16" over-all, Example 18" = 18-9/16"

Sample Growth Illustration shown below

for a 36" w x 24" d Shelving System
 Shelf dimensions: 35-13/16" w x 23-15/16" d
 Centerline of T-Posts: 36"
 Overall growth in width = 1-1/2"
 Overall growth in depth = 9/16"

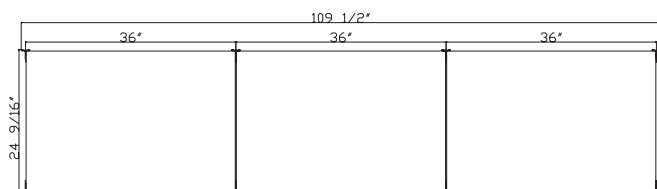

Shelf Clips



T-Post Uprights

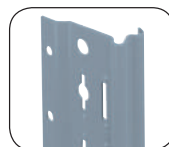

Angle Uprights



Shelf Load Capacities for 8000 Series Shelving are listed above.

Shelves available in multi- or single pack quantities. Contact Lyon Customer Service at 800-323-0082.

OPEN SHELVING



36" WIDE

Ideal for storing packaged stock and other material where high visibility is a concern.

42" AND 48" WIDE

WIDER FOR GREATER STORAGE FLEXIBILITY

- Greater lateral clearance yields more shelf space for long, unwieldy items and offers more flexibility for storing packaged stock
- Both 42" and 48" wide sections integrate with comparable 36" wide 8000 series units, and with each other
- Features Lyon T-Post Uprights and "Box W" shelf design

In-Stock colors available:
Dove Gray and Putty.

No. of STARTERS	36" w x 12" d x 84" h		36" w x 18" d x 84" h		36" w x 24" d x 84" h	
	STARTERS	ADD-ONS	STARTERS	ADD-ONS	STARTERS	ADD-ONS
22-GAUGE MEDIUM DUTY, BOX "W"						
5	8005SM	8005M	8006SM	8006M	8007SM	8007M
6	8040SM	8040M	8041SM	8041M	8042SM	8042M
6**	N/A	N/A	N/A	N/A	N/A	N/A
7	8030SM	8030M	8031SM	8031M	8032SM	8032M
8	8020SM	8020M	8021SM	8021M	8022SM	8022M
20-GAUGE HEAVY DUTY, BOX "W"						
5	8005SH	8005H	8006SH	8006H	8007SH	8007H
6	8040SH	8040H	8041SH	8041H	8042SH	8042H
6**	N/A	N/A	N/A	N/A	N/A	N/A
7	8030SH	8030H	8031SH	8031H	8032SH	8032H
8	8020SH	8020H	8021SH	8021H	8022SH	8022H
18-GAUGE EXTRA HEAVY DUTY, BOX "W"						
5	8005SX	8005X	8006SX	8006X	8007SX	8007X
6	8040SX	8040X	8041SX	8041X	8042SX	8042X
6**	N/A	N/A	N/A	N/A	N/A	N/A
7	8030SX	8030X	8031SX	8031X	8032SX	8032X
8	8020SX	8020X	8021SX	8021X	8022SX	8022X
18-GAUGE TRADITIONAL FLANGED						
5	8005S	8005	8006S	8006	8007S	8007
6	8040S	8040	8041S	8041	8042S	8042
6**	N/A	N/A	N/A	N/A	N/A	N/A
7	8030S	8030	8031S	8031	8032S	8032
8	8020S	8020	8021S	8021	8022S	8022

No. of STARTERS	42" w x 12" d x 84" h		42" w x 18" d x 84" h		42" w x 24" d x 84" h	
	STARTERS	ADD-ONS	STARTERS	ADD-ONS	STARTERS	ADD-ONS
20-GAUGE, BOX "W"						
5	8046SH	8046H	8047SH	8047H	8048SH	8048H
6	8056SH	8056H	8057SH	8057H	8058SH	8058H
7	8066SH	8066H	8067SH	8067H	8068SH	8068H
8	8073SH	8073H	8074SH	8074H	8075SH	8075H

No. of STARTERS	48" w x 12" d x 84" h		48" w x 18" d x 84" h		48" w x 24" d x 84" h	
	STARTERS	ADD-ONS	STARTERS	ADD-ONS	STARTERS	ADD-ONS
20-GAUGE, BOX "W"						
5	8340SH	8340H	8341SH	8341H	8342SH	8342H
6	8346SH	8346H	8347SH	8347H	8348SH	8348H
7	8396SH	8396H	8397SH	8397H	8398SH	8398H
8	8363SH	8363H	8364SH	8364H	8365SH	8365H
18-GAUGE, BOX "W"						
5	8340SX	8340X	8341SX	8341X	8342SX	8342X
6	8346SX	8346X	8347SX	8347X	8348SX	8348X
7	8396SX	8396X	8397SX	8397X	8398SX	8398X
8	8363SX	8363X	8364SX	8364X	8365SX	8365X

**NOTE: Back open with lateral cross brace.

CLOSED SHELVING



Five Shelf Closed Starter

Five Shelf Closed Add-On

36" WIDE

Can be used to divide work and storage space into separate areas.

42" AND 48" WIDE

WIDER FOR GREATER STORAGE FLEXIBILITY

- Greater lateral clearance yields more shelf space for long, unwieldy items and offers more flexibility for storing packaged stock
- Both 42" and 48" wide sections integrate with comparable 36" wide 8000 series units, and with each other
- Features Lyon T-Post Uprights and "Box W" shelf design

In-Stock colors available:
Dove Gray and Putty.

No. of STARTERS	36" w x 12" d x 84" h		36" w x 18" d x 84" h		36" w x 24" d x 84" h	
	STARTERS	ADD-ONS	STARTERS	ADD-ONS	STARTERS	ADD-ONS
22-GAUGE MEDIUM DUTY, BOX "W"						
5	8037SM	8037M	8038SM	8038M	8039SM	8039M
6	8260SM	8260M	8261SM	8261M	8262SM	8262M
6**	8270SM	8270M	8271SM	8271M	8272SM	8272M
7	8090SM	8090M	8091SM	8091M	8092SM	8092M
8	8080SM	8080M	8081SM	8081M	8082SM	8082M
20-GAUGE HEAVY DUTY, BOX "W"						
5	8037SH	8037H	8038SH	8038H	8039SH	8039H
6	8260SH	8260H	8261SH	8261H	8262SH	8262H
6**	8270SH	8270H	8271SH	8271H	8272SH	8272H
7	8090SH	8090H	8091SH	8091H	8092SH	8092H
8	8080SH	8080H	8081SH	8081H	8082SH	8082H
18-GAUGE EXTRA HEAVY DUTY, BOX "W"						
5	8037SX	8037X	8038SX	8038X	8039SX	8039X
6	8260SX	8260X	8261SX	8261X	8262SX	8262X
6**	8270SX	8270X	8271SX	8271X	8272SX	8272X
7	N/A	N/A	N/A	N/A	N/A	N/A
8	N/A	N/A	N/A	N/A	N/A	N/A
18-GAUGE TRADITIONAL FLANGED						
5	8037S	8037	8038S	8038	8039S	8039
6	8260S	8260	8261S	8261	8262S	8262
6**	8270S	8270	8271S	8271	8272S	8272
7	8090S	8090	8091S	8091	8092S	8092
8	8080S	8080	8081S	8081	8082S	8082

No. of STARTERS	42" w x 12" d x 84" h		42" w x 18" d x 84" h		42" w x 24" d x 84" h	
	STARTERS	ADD-ONS	STARTERS	ADD-ONS	STARTERS	ADD-ONS
20-GAUGE, BOX "W"						
5	8266SH	8266H	8267SH	8267H	8268SH	8268H
6	8276SH	8276H	8277SH	8277H	8278SH	8278H
7	8286SH	8286H	8287SH	8287H	8288SH	8288H
8	8289SH	8289H	8290SH	8290H	8291SH	8291H

No. of STARTERS	48" w x 12" d x 84" h		48" w x 18" d x 84" h		48" w x 24" d x 84" h	
	STARTERS	ADD-ONS	STARTERS	ADD-ONS	STARTERS	ADD-ONS
20-GAUGE, BOX "W"						
5	8334SH	8334H	8335SH	8335H	8336SH	8336H
6	8331SH	8331H	8332SH	8332H	8333SH	8333H
7	8391SH	8391H	8392SH	8392H	8393SH	8393H
8	8343SH	8343H	8344SH	8344H	8345SH	8345H
18-GAUGE, BOX "W"						
5	8334SX	8334X	8335SX	8335X	8336SX	8336X
6	8331SX	8331X	8332SX	8332X	8333SX	8333X
7	8391SX	8391X	8392SX	8392X	8393SX	8393X
8	8343SX	8343X	8344SX	8344X	8345SX	8345X

HOW TO BUILD AN 8000 SERIES SHELVING SYSTEM

STEP 1

Select Upright Assembly

Choose Open or Closed Upright
Determine depth and height of
Shelving Systems

STEP 2

Select Back Bracing

Choose Lateral Cross Brace or
Solid Back Panel

STEP 3

Select Shelves

Determine dimensions
Choose Gauge
Choose type-
Box "W", Flanged, Wire
Galvanized or Bin

STEP 4

Select Accessories and/or Additional Components

STEP 5

Select Anchoring and Additional Bracing Components

Foot Plate • Floor Angle • Anchor • End-Tie Clip

End-Tie Clip

(see step 5)

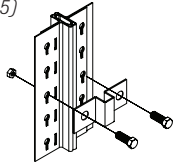

Anchoring System

(see step 5)

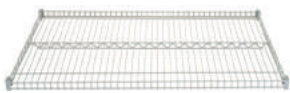
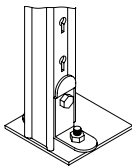

Wire Shelves are all-welded, and constructed from heavy-gauge steel wire and heavy-gauge channels. Shelf load capacity ranges from 350 lbs.* (48" wide) to 500 lbs.* (36" wide) per shelf. Shelves slip easily onto uprights using Lyon shelf clips.



STEP 1 Select Upright Assembly

(A) Open Shelving T-Post Upright Assembly

No. 8530 - 12"d x 84"h
No. 8536 - 18"d x 84"h
No. 8541 - 24"d x 84"h
No. 8531 - 12"d x 96"h

No. 8538 - 18"d x 96"h
No. 8542 - 24"d x 96"h
No. 8532 - 12"d x 120"h
No. 8539 - 18"d x 120"h
No. 8543 - 24"d x 120"h
No. 8841 - 30"d x 84"h

(B) Closed Shelving T-Post Upright Assembly

No. 8500 - 12"d x 84"h
No. 8506 - 18"d x 84"h
No. 8511 - 24"d x 84"h
No. 8501 - 12"d x 96"h

No. 8507 - 18"d x 96"h
No. 8512 - 24"d x 96"h
No. 8502 - 12"d x 120"h
No. 8508 - 18"d x 120"h
No. 8513 - 24"d x 120"h

STEP 2 Select Back Bracing

(D) Open Lateral (Back) Cross Brace

No. 87901 - fits all 30"w & 36"w shelving including all counter shelving
No. 87911 - fits all 42"w shelving
No. 83301 - fits all 48"w shelving except counter shelving

Parts listed in single pack quantities, for multi-pack quantities,
contact Customer Service at 1-800-323-0082

(E) Shelving Backs

No. 86001 - 36"w x 39"h
No. 86011 - 36"w x 84"h
No. 86021 - 36"w x 96"h
No. 86031 - 36"w x 120"h
No. 86061 - 42"w x 84"h

No. 86071 - 42"w x 96"h
No. 86081 - 42"w x 120"h
No. 83161 - 48"w x 84"h
No. 86481 - 30"w x 84"h
No. 8882 - Additional Slotted Hex Head
Screws to attach shelving backs

STEP 3 Select Shelves (All shelves include 4 clips)

(F) Medium Duty Shelves 22-Gauge Box "W"

(Without Label holder)
No. 8560M – 36" w x 12" d
No. 8561M – 36" w x 18" d
No. 8562M – 36" w x 24" d

Heavy Duty Shelves 20-Gauge Box "W"

(Without Label holder)
No. 8593H – 30" w x 30" d
No. 8560H – 36" w x 12" d
No. 8561H – 36" w x 18" d

No. 8562H – 36" w x 24" d
No. 8565H – 42" w x 12" d
No. 8566H – 42" w x 18" d
No. 8567H – 42" w x 24" d
No. 8300H – 48" w x 12" d
No. 8301H – 48" w x 18" d
No. 8302H – 48" w x 24" d

Extra Heavy Duty Shelves 18-Gauge Box "W"

(Without Label holder)
No. 8560X – 36" w x 12" d
No. 8561X – 36" w x 18" d
No. 8562X – 36" w x 24" d

No. 8300X – 48" w x 12" d
No. 8301X – 48" w x 18" d
No. 8302X – 48" w x 24" d

(G) Traditional Shelves 18-Gauge Flanged[†]

(Without Label holder)
No. 83001 – 48" w x 12" d
No. 83011 – 48" w x 18" d
No. 83021 – 48" w x 24" d
No. 85601 – 36" w x 12" d
No. 85611 – 36" w x 18" d
No. 85621 – 36" w x 24" d

Wire Shelves*

No. 8561WS1N – 36" w x 18" d
No. 8562WS1N – 36" w x 24" d
No. 8301WS1N – 48" w x 18" d
No. 8302WS1N – 48" w x 24" d

Galvanized Shelves

No. 8560GLV1 – 36" w x 12" d
No. 8561GLV1 – 36" w x 18" d
No. 8562GLV1 – 36" w x 24" d

Parts listed in single pack quantities, for multi-pack quantities, contact Customer Service at 1-800-323-0082

STEP 4 Accessories

(C) Open Rack End Cross Braces (2 pk)

No. 85552 – for 12" d open rack ends
No. 85562 – for 18" d open rack ends
No. 85572 – for 24" d open rack ends
No. 85582 – for 30" d open uprights
No. 85592 – for 36" d open uprights

Roll-Formed T-Posts Only (2 pk)

No. 8550 – 84" h
No. 8551 – 96" h
No. 8552 – 120" h

(H) 8000 Series Clips

No. 8854 *(Shelf Clip)*
No. 65160 *(BSR Integration Clip)*

(L) Bin Fronts** (10 pk)

No. 8755 – 36" w x 1" h
No. 8756 – 36" w x 3" h
No. 8757 – 42" w x 1" h
No. 8758 – 42" w x 3" h
No. 8324 – 48" w x 1" h
No. 8325 – 48" w x 3" h

Back-to-Shelf Clips***

Tightens back to shelf
No. 8850WS – for Wire shelves
No. 8851 – for Flanged shelves
No. 8853 – for Box "W" shelves
Side-to-Back Clip
No. 8850 – Connects T-Post to back

Base Shelf Clip

No. 8807 – 1-1/2"
Allows floor-level shelf with beaded post

(R) Base Strips** (10 pk)

No. 8765 – 36" w x 1-7/8" h
No. 8766 – 36" w x 4-7/8" h
No. 8767 – 42" w x 1-7/8" h
No. 8768 – 42" w x 4-7/8" h
No. 8327 – 48" w x 1-7/8" h

(J) Shelf Dividers and Slides *(contact customer service)*

Shelf Box Dividers

(contact customer service)

Swinging Doors for Shelving

(contact customer service)

STEP 5 Select Anchoring and Additional Bracing Components

Upright to Floor Angle

No. 8859 –
(4) per section of shelving

Footplate

No. 8860 – 3" x 3" x 1/4" plate
(1) per post

Anchor

No. 8861 – 3/8" Dia. x 3" wedge
anchor (1) per post

End-Tie Clip****

No. 8856 –
Ties sections back-to-back

Shim Plates (for uneven floors)

No. 8852 – used w/out anchoring

No. 8862 – 18-gauge used w/anchor

No. 8863 – 14-gauge used w/anchor

No. 8864 – 12-gauge used w/anchor

Arch Sway Brace 36

No. XX8809

Notes:

Shelving accessories can be used with both the T-Post.

Lateral and end cross braces shown for illustrative purposes only. For quantities required and general erection instructions, see shelving installation instruction #9110-CA (included in standard packaged units). Installation must be level and plumb.

[†]Must request punching for bolting to uprights.

**Wire shelving sections with backs require Cat. No. 8850WS Back-to-Shelf Clip Item above.*

****Not included with shelving backs. Order separately.*

*****2 per location at ends and every 3rd upright.*

HOW TO ORDER A **CUSTOM BULK STORAGE RACK**

STEP 1 Select Upright Assembly

Select Uprights by size in either fully welded set-up or knocked down

STEP 2 Select Beam

Select Beam based on width of opening and weight capacity needed:

- Heavy and Extra Heavy-Duty "Z" Beams
- Low-Profile Beams

STEP 3 Select Decking

Select Decking based on size and style desired:

- Solid Decking
- Particle Board Decking
- Ribbed Decking
- Wire Decking

STEP 4 Select Front-to-Back Supports

Select Front-To-Back Support based on depth of upright and decking

STEP 5 Select Accessories



Color Selection

IN STOCK

DD Dove Gray

ALSO AVAILABLE

PP Putty

BB Wedgewood Blue

i DIMENSIONS FOR BULK STORAGE RACKS

When figuring floor space for Lyon bulk storage racks, first add 4⁷/₃₂" to nominal beam length for width of single section.

Next, add 2¹⁵/₃₂" to nominal beam length for each additional section.

Then, add ⁹/₁₆" to nominal depth of upright assembly.

Also, racks must be level and plumb and installed per assembly instruction #10206-AA.

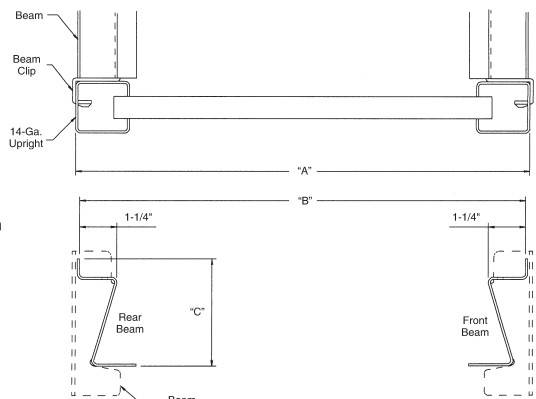
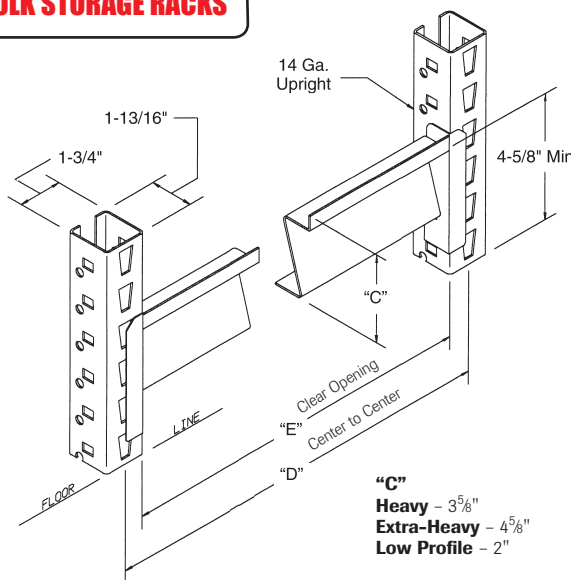

Nominal Rack Depth	Rack Depth "A"	Inside Depth "B"
15"	15 ⁹ / ₁₆ "	15 ¹ / ₄ "
18"	18 ⁹ / ₁₆ "	18 ¹ / ₄ "
24"	24 ⁹ / ₁₆ "	24 ¹ / ₄ "
30"	30 ⁹ / ₁₆ "	30 ¹ / ₄ "
36"	36 ⁹ / ₁₆ "	36 ¹ / ₄ "
42"	42 ⁹ / ₁₆ "	42 ¹ / ₄ "
48"	48 ⁹ / ₁₆ "	48 ¹ / ₄ "

Capacities shown are maximum safe evenly distributed static loads per pair of beams with front-to-back support. Upright capacities are based on beam centers no greater than 36".

HOW TO ORDER A **CUSTOM BULK STORAGE RACK**

STEP 1

Select Upright Assembly

Choose All-Welded or K.D.

- Welded Upright has tubular bracing, mig-welded to post
- K.D. (knocked down) Upright includes two posts and two or more bolt on ladder braces
 - Upright: 1³/₄" x 1¹³/₁₆"
 - 14-gauge
 - Adjustment on 1¹/₂" centers
- 10,000 lb. capacity per section (All-Welded or K.D.)

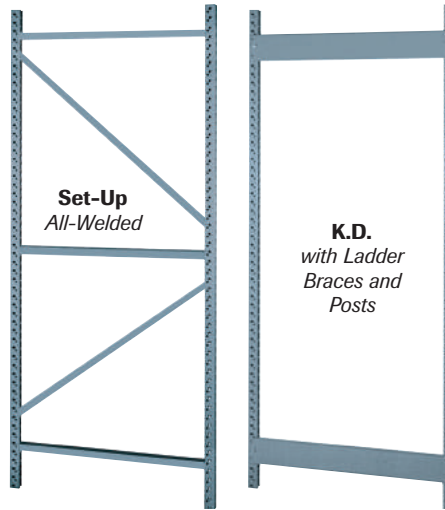

K.D. Ladder Braces Only

Use as replacement, or as a component

K.D. Upright Posts Only

Height	Cat. No.
60"	63602
72"	63603
84"	63604
96"	63605
120"	63607
144"	63609

Depth	Cat. No.
15"	63515
18"	63518
24"	63524
30"	63530
36"	63536
42"	63542
48"	63548

Depth	60" High		72" High		84" High		96" High		120" High		144" High	
	Set-Up	K.D.	Set-Up	K.D.	Set-Up	K.D.	Set-Up	K.D.	Set-Up	K.D.	Set-Up	K.D.
15"	N/A	63152	N/A	63153	N/A	63154	N/A	63155	N/A	63157	N/A	63159
18"	N/A	63182	N/A	63183	N/A	63184	N/A	63185	N/A	63187	N/A	63189
24"	64242	63242	64243	63243	64244	63244	64245	63245	64247	63247	64249	63249
30"	64302	63302	64303	63303	64304	63304	64305	63305	64307	63307	64309	63309
36"	64362	63362	64363	63363	64364	63364	64365	63365	64367	63367	64369	63369
42"	64422	63422	64423	63423	64424	63424	64425	63425	64427	63427	64429	63429
48"	64482	63482	64483	63483	64484	63484	64485	63485	64487	63487	64489	63489

STEP 2

• Heavy and Extra Heavy-Duty "Z" Beams

Unique "Z" beam design increases strength and load capacity, resists tipping and eliminates wasted space, front-to-back. Beam clips are mig-welded for added strength. Fold in lock tab easily engages for security against displacement.

• Low-Profile Beams

Offer light weight, high-density alternative for commercial applications. Narrow height design increases vertical storage capacity.

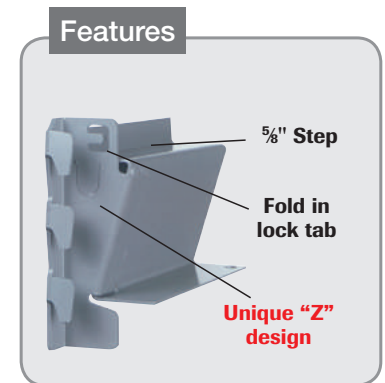
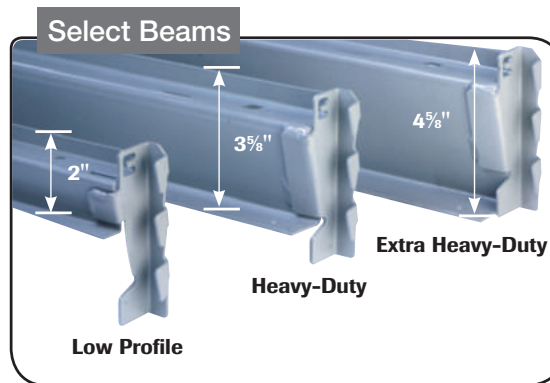

Nominal Width	Actual Width	"D"	"E"	Heavy-Duty Cat. No.	Capacity	Extra-Heavy Duty Cat. No.	Capacity	Low Profile Cat. No.	Capacity
48"	48 ¹ / ₂ "	50 ¹⁵ / ₃₂ "	48 ²³ / ₃₂ "	62148	3,300 lbs.	*	*	62048	665 lbs.
60"	60 ¹ / ₂ "	62 ¹⁵ / ₃₂ "	60 ²³ / ₃₂ "	62160	2,600 lbs.	*	*	62060	530 lbs.
72"	72 ¹ / ₂ "	74 ¹⁵ / ₃₂ "	72 ²³ / ₃₂ "	62172	1,900 lbs.	62272	3,300 lbs.	62072	440 lbs.
84"	84 ¹ / ₂ "	86 ¹⁵ / ₃₂ "	84 ²³ / ₃₂ "	62184	1,775 lbs.	*	*	62084	380 lbs.
96"	96 ¹ / ₂ "	98 ¹⁵ / ₃₂ "	96 ²³ / ₃₂ "	62196	1,650 lbs.	62296	3,300 lbs.	62096	330 lbs.

Capacities shown are maximum safe evenly distributed static loads per pair of beams with front-to-back support. Upright capacities are based on beam centers no greater than 36".
*Items available through manufactured schedule.

HOW TO ORDER A **CUSTOM BULK STORAGE RACK**

STEP 3 Select Decking

Two to three panels per level are required based on beam width (see chart below).

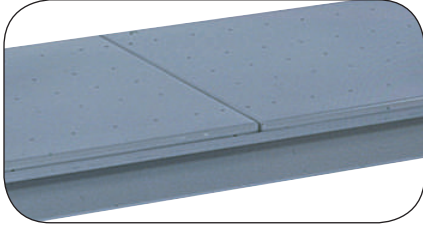

Solid Decking - Features Lyon heavy-duty industrial shelves for a smooth uninterrupted decking surface.

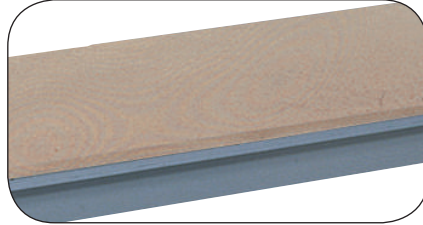

Particle Board Decking - Durable, 5/8" thick particle board decking.

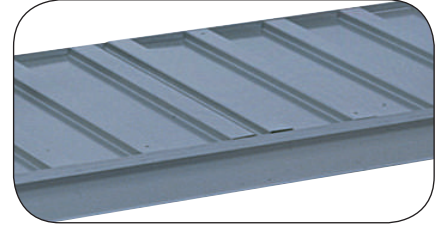

Ribbed Decking - Versatile 20-gauge ribbed decking. Ribs allow for space to grab packages easily and prevent pinched fingers. 1 3/4" w x 5/8" d rib.

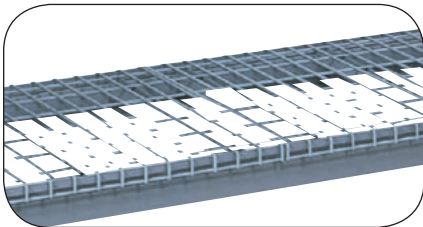

Heavy-Duty Waterfall Decking - This deck is the best choice when air circulation and light penetration are required. Also allows water to flow in the event a sprinkler system is activated. Available in Frost Gray (add prefix FF to the Cat. No.) Featuring 4" x 2" wire mesh with heavy gauge welded channels for added strength and a waterfall along both front and rear edge.

Beam Width Quantity of Decking Panels Required

48"	2 - 24" wide
60"	1 - 24" wide + 1 - 36" wide
72"	2 - 36" Wide
84"	2 - 24" wide + 1 - 36" wide
96"	1 - 24" wide + 2 - 36" wide

Parts listed in single pack quantities, for multi-pack quantities, contact Customer Service at 1-800-323-0082

Width	Depth	Ribbed Decking		H. D. Wire Decking		Wire Decking		Solid Decking		Particle Board Decking	
		Cat. No.	Capacity	Cat. No.	Capacity	Cat. No.	Capacity	Cat. No.	Capacity	Cat. No.	Capacity
24"	24"	652241	1,400 lbs.	65454	1,200 lbs.	65454FW	750 lbs.	*	*	*	*
24"	30"	652301	1,200 lbs.	65456	1,100 lbs.	*	*	*	*	*	*
24"	36"	652361	1,000 lbs.	65458	1,200 lbs.	65458FW	920 lbs.	8562H	800 lbs.	72508	750 lbs.
24"	42"	652421	800 lbs.	65460	1,000 lbs.	*	*	8567X	880 lbs.	-	-
24"	48"	652481	600 lbs.	65462	1,000 lbs.	65462FW	340 lbs.	8302X	750 lbs.	72528	750 lbs.
36"	24"	653241	1,800 lbs.	65472	1,200 lbs.	65472FW	460 lbs.	8562H	800 lbs.	72508	750 lbs.
36"	30"	653301	1,600 lbs.	65474	1,100 lbs.	*	*	8558H	740 lbs.	*	*
36"	36"	653361	1,400 lbs.	65476	1,200 lbs.	65476FW	545 lbs.	8586X	850 lbs.	*	*
36"	42"	653421	1,100 lbs.	—	—	*	*	8589X	820 lbs.	*	*
36"	48"	653481	900 lbs.	65480	1,000 lbs.	65480FW	385 lbs.	8592X	840 lbs.	72532	750 lbs.

Capacities are based on evenly distributed static load, with beams joined by correct number of front-to-back supports and no allowance for shock or uneven loading. Load is limited to support capacity of beams and upright assemblies.

*Items available through manufactured schedule.

HOW TO ORDER A **CUSTOM BULK STORAGE RACK**

STEP 4 Select Front-to-Back Supports

One to four supports per level are required based on beam width and type of decking (see chart below).

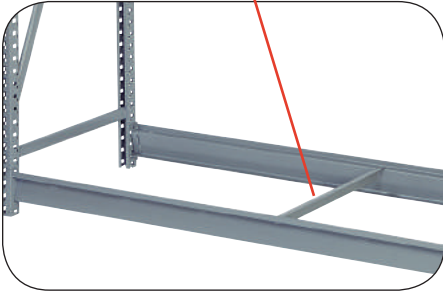

Used to minimize beam rotation under heavy loads. Also serves as a plywood support. No hardware or tools needed.

Rack Depth	Front-to-Back Supports Cat. No.
15"	65815
18"	65818
24"	65824
30"	65830
36"	65836
42"	65842
48"	65848

Minimum required when used with:

Beam Width	Plywood/ Particle Board	Solid/Ribbed/ Flat Wire/ No Deck
48"	2	1
60"	2	1
72"	3	2
84"	3	2
96"	4	2

STEP 5

Select Accessories



Back-To-Back Support

Ties bulk storage rack back to back, maintains stability and spacing without interfering with storage space. Overall Extension: 12" - 17½"

No. 65140



Back-To-Wall Support

Bolts to upright member and wall to maintain shelving stability. Overall Extension: 12" - 17¼"

No. 65145

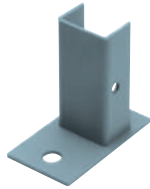

Anchoring Foot

To anchor upright assembly to floor. Dove Gray only.

No. 65130

Wedge Anchor

⅜" dia x 3", 1 per post

No. 8861



End-Tie Plate

Ties Bulk Storage Rack back to back to maintain uniform spacing and stability. 3½" x 2½"

No. 65142

For Mezzanine Applications



Mezzanine Splice Channels

For two-level Bulk Storage Rack applications, simply insert reinforcing splice channels into bottom upright assembly posts and fit second-level upright assembly posts over channel extensions. The galvanized splice channels provide rigidity at the splice.

No. 65120



EASILY INTEGRATE BULK STORAGE RACKS

Bulk Storage Racks integrates seamlessly with 8000 Series shelving for a complete storage system.

8000 Series/BSR Integration Clip **No. 65160**



HOW TO ORDER RIVET RACK UNITS

Each rack will require:

- 4 uprights
- 2 width beams per level
- 2 depth beams per level

Beams 60" and wider require center supports.

All units utilizing single rivet beams require double rivet beams on both the top and bottom levels.

Available in these Colors

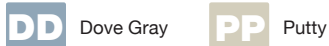

STEP 1 14-Gauge Steel Uprights

Angle Post Part No.	T-Post Part No.	Height (Feet)
72001H	-	3'-3"
72003H	72017H	5'
72004H	72018H	6'
72005H	72019H	7'
72006H	72020H	8'
72007H	72021H	10'
72008H	72022H	12'
72009H	72080H	14'
72010H	72081H	16'
72011H	72082H	18'
72012H	72083H	20'

STEP 2 and STEP 3 14 Gauge Steel Beams- Determine Width & Depth

Double Rivet Low Profile Beam	BEAM LENGTH					
	15"		30"		42"	
	Part No.	Capacity	Part #	Capacity	Part #	Capacity
	72100	350	72103	350	72105	250

C-Channel Heavy Duty Beam	BEAM LENGTH	
	69"	
	Part No.	Capacity
	72061H	1400

Single Rivet Light-Duty Beam	BEAM LENGTH							
	18"		24"		36"		48"	
	Part No.	Capacity	Part #	Capacity	Part #	Capacity	Part #	Capacity
	72028H	350	72029H	350	72031H	350	72033H	250

Double Rivet Medium-Duty Beam	BEAM LENGTH							
	18"		24"		36"		48"	
	Part No.	Capacity	Part #	Capacity	Part #	Capacity	Part #	Capacity
	72043H	800	72044H	800	72047H	800	72049H	1000

Double Rivet Medium-Duty Beam	BEAM LENGTH									
	60"		69"		72"		84"		96"	
	Part No.	Capacity	Part #	Capacity	Part #	Capacity	Part #	Capacity	Part #	Capacity
	72050H	800	72051H	800	72053H	800	72054H	700	72055H	650

Center supports are required for double rivet beams 60" and wider. For 60" and 69" use 1 center support, and for lengths over 72" use 2 center supports. Beams shorter than 60" do not require center supports.

STEP 4 Select Center Supports

Part No.	Length (Inches)
72071	15"
72073	18"
72074	24"
72075	30"
72077	36"
72078	42"
72079	48"

STEP 5 Select Decking Options

WIRE DECKING		
Part #	Dimensions W" x D"	Capacity (lbs.)
72606	36" X 18	250
72608	36" x 24"	250
72626	48" X 18	600
72628	48" x 24"	600
72632	48" x 36"	600
72634	48" x 48"	600
72644	60" x 24"	550
72646	60" x 36"	550
72648	60" x 48"	500
72654	72" x 24"	800
72656	72" x 36"	800
72658	72" x 48"	800
72680	69" x 16"	800

PARTICLE BOARD	
Part #	Dimensions W" x D"
72506	36" X 18
72508	36" x 24"
72526	48" X 18
72528	48" x 24"
72532	48" x 36"
72534	48" x 48"
72544	60" x 24"
72546	60" x 36"
72548	60" x 48"
72554	72" x 24"
72556	72" x 36"
72558	72" x 48"
72564	96" x 24"
72566	96" x 36"
72568	96" x 48"
72580	69" x 16"

PRE-ENGINEERED 84" HIGH RIVET RACK

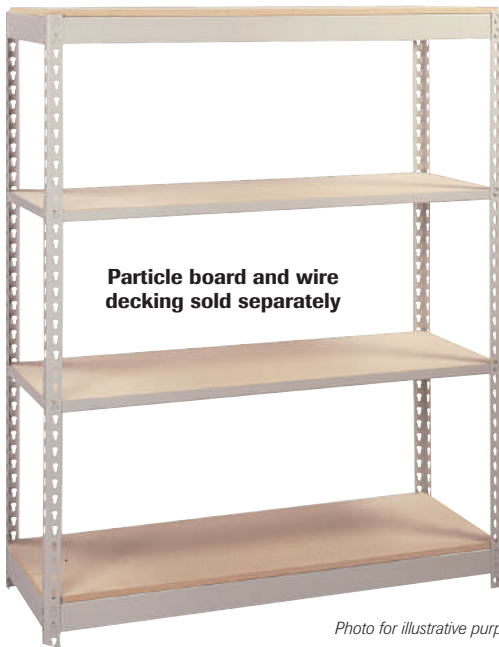

Particle board and wire decking sold separately

Photo for illustrative purposes only

- Beams drop into slots on uprights to create a sturdy, rigid structure
- Starter uprights are 14-gauge angle posts for use as stand alone sections or at the ends of two or more sections
- Add-on uprights are 14-gauge T-posts for use as intermediate posts in multiple section rows
- Easy assembly
- Adjustable every 1½"

Color Selection

IN STOCK

DD Dove Gray

PP Putty

W x D x H	Capacity lbs.	3 Level		4 Level	
		Starter	Add-On	Starter	Add-On
Double-Rivet, Medium-Duty Flanged Beam					
48" x 24" x 84"	1,000	73020	73020A	73040	73040A
48" x 36" x 84"	1,000	73021	73021A	73041	73041A
48" x 48" x 84"	1,000	73022	73022A	73042	73042A
60" x 24" x 84"	800	73023	73023A	73043	73043A
60" x 36" x 84"	800	73024	73024A	73044	73044A
60" x 48" x 84"	800	73025	73025A	73045	73045A
72" x 24" x 84"*	800	73026	73026A	73046	73046A
72" x 36" x 84"*	800	73027	73027A	73047	73047A
72" x 48" x 84"*	800	73028	73028A	73048	73048A
96" x 24" x 84"*	650	73029	73029A	73049	73049A
96" x 36" x 84"*	650	73030	73030A	73050	73050A
96" x 48" x 84"*	650	73031	73031A	73051	73051A
"C" Channel, Heavy-Duty Beam					
96" x 24" x 84"*	1,200	73035	73035A	73055	73055A
96" x 36" x 84"*	1,200	73036	73036A	73056	73056A
96" x 48" x 84"*	1,200	73037	73037A	73057	73057A

*Includes Center support. Decking sold separately.

ACCESSORIES AND RELATED PRODUCTS

Particle Board Decking

Versatile particle board decking is 5/8" thick and pre-cut to size for use with Lyon rivet rack. For general purpose and record storage applications.

Rivet Rack Wire Decking

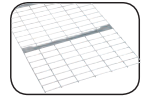

Manufactured with 4-gauge wire 2" x 4" mesh. It meets fire code standards and features easy drop in installation, enhanced sprinkler system effectiveness and durable baked on enamel finish. Available in Frost Gray.

Actual Size	Cat. No.
36" x 12"	72504
36" x 18"	72506
36" x 24"	72508
48" x 12"	72524
48" x 18"	72526
48" x 24"	72528
48" x 36"	72532
48" x 48"	72534
60" x 24"	72544
60" x 36"	72546
60" x 48"	72548
72" x 24"	72554
72" x 36"	72556
72" x 48"	72558
96" x 24"	72564
96" x 36"	72566
96" x 48"	72568
69" x 16"	72580
69" x 32"	72582

W x D	Capacity	Cat. No.
36" w x 12" d	350 lbs.	72604
36" w x 18" d	250 lbs.	72606
36" w x 24" d	250 lbs.	72608
48" w x 12" d	600 lbs.	72624
48" w x 18" d	600 lbs.	72626
48" w x 24" d	600 lbs.	72628
48" w x 36" d	600 lbs.	72632
48" w x 48" d	600 lbs.	72634
60" w x 24" d	550 lbs.	72644
60" w x 36" d	550 lbs.	72646
60" w x 48" d	500 lbs.	72648
72" w x 24" d	800 lbs.	72654
72" w x 36" d	800 lbs.	72656
72" w x 48" d	800 lbs.	72658
69" w x 16" d	800 lbs.	72680
69" w x 32" d	800 lbs.	72682

Not recommended for single rivet beam applications.

Wall Tie

No. 72110 – Wall Tie 9"L, Fastens back to wall



Double Row Tie

No. 72115 – Double Row Tie 18"L, Ties double rows together

Hanging Bar for Clothes Hangers

No. 72120 – 36"L
No. 72121 – 42"L



Rivet Rack Tire

No. 72130 – Rivet Rack Tire Beam 60" (not shown)

Tie Plates

Lock posts together to join two or more racks side by side.
No. 72090 – 2 7/8" x 2 5/8"



Record Storage Box Support Rails

No. 72095 – 1 1/2" w x 16" d*
No. 72096 – 1 1/2" w x 32" d*
*Can only be used with 72052HR.

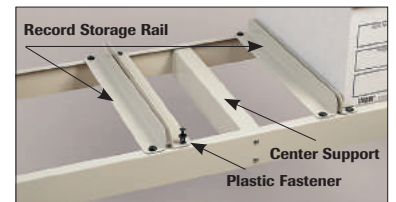

Center Supports

Required for beams wider than 60".

No. 72070 – 12" d
No. 72071 – 15" d
No. 72072 – 16" d
No. 72073 – 18" d
No. 72074 – 24" d
No. 72075 – 30" d
No. 72076 – 32" d
No. 72077 – 36" d
No. 72078 – 42" d
No. 72079 – 48" d

CUSTOM DESIGN MODULAR DRAWERS IN SHELVING UNITS



EXAMPLE

Shelving System is
30"w x 30"d x 84"h

Qty.	Cat. No.	Description
2	DD8886	Upright 30"d x 84"h
1	DD86481	Back, 30"w x 84"h
5	DD8593H1	Shelf, 30"w x 30"d
1	KKN483030DGS	Support, 36"h
2	KKN063030NN000	Drawer, 3-7/8" usable
4	KKN093030NN000	Drawer, 6-1/4" usable

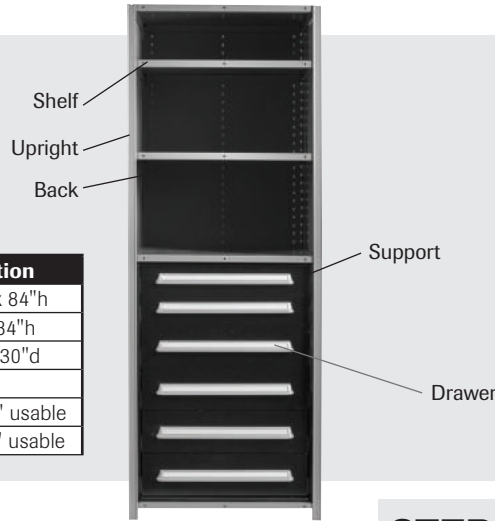

STEP 1 Shelving Selection

Select shelving.

Cat. No.	Description
FRAME WORK	
8886	Upright Assembly (2 required per starter section)*
86481	Shelving Back (1 required per section)
SHELVES	
8593H1	Shelf 30"w x 30"d (minimum 4 per section required)

Note: Shelves are required immediately above and below drawer guide support.
*Only 1 required per add-on selection.

STEP 2 Shelving Color Selection

Determine your color, then add the two (2) letter digits as a **prefix** to the shelving catalog numbers chosen in step 1.



STEP 3 Support Selection

Select the drawer guide support(s), depending on whether you want a short stack of drawers (18" High) or a tall stack (36" High) or a combination.

DRAWER GUIDE SUPPORTS	
Cat. No.	Description
N253030DGS	Drawer Guide Support, 18"h
N483030DGS	Drawer Guide Support, 36"h

STEP 4 Drawer Selection

Select the number of drawers desired. (see example).

MODULAR DRAWERS FOR 30"W SHELVING			EXAMPLE
Cat. No.	Front Height	Usable Height	
N043030NN000	3-1/16"	2-1/4"	When selecting drawer configurations you must add the drawer numbers to equal the first 2 digits of the <i>Drawer Guide Support</i> . Drawer Guide Support No. N253030DGS (3) No. N043030NN000 drawers = 12 (1) No. N063030NN000 drawer = 06 (1) No. N073030NN000 drawer = 07 <hr/> Total = 25
N053030NN000	3-7/8"	3"	
N063030NN000	4-5/16"	3-7/8"	
N073030NN000	5-7/16"	4-5/8"	
N083030NN000	6-3/16"	5-3/8"	
N093030NN000	7"	6-1/4"	
N103030NN000	7-3/4"	7"	
N113030NN000	8-9/16"	7-3/4"	
N123030NN000	9-3/8"	8-1/2"	
N133030NN000	10-1/4"	9-3/8"	
N143030NN000	10-7/8"	10-1/8"	
N153030NN000	11-3/4"	10-7/8"	
N163030NN000	12-1/2"	11-3/4"	
N173030NN000	13-15/16"	12-1/2"	
N183030NN000	14-1/16"	13-1/4"	
NRS3030NN000	3-7/8"	3"	

STEP 5 Support/Drawer Color Selection

Determine your color, then add the two (2) letter digits as a **prefix** to the catalog numbers chosen.

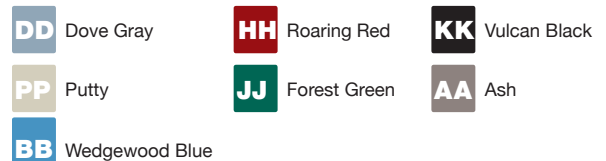

ENGINEERED SHELVING PROJECTS



Two-level Shelving

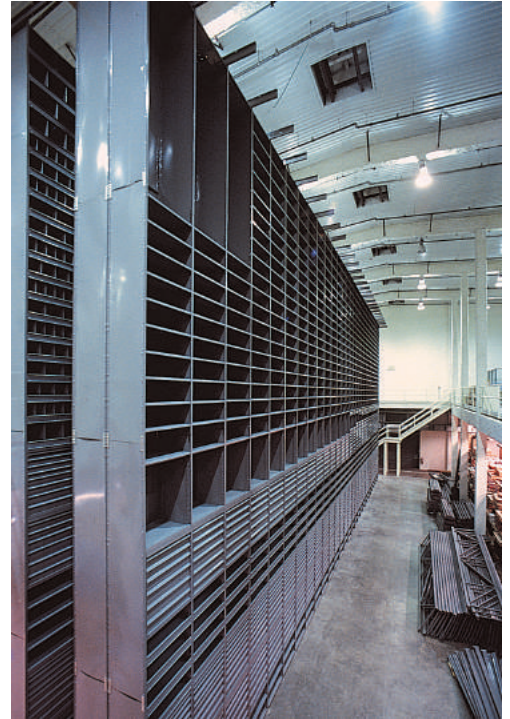

Multiple Level Installations



Shelving Supported Mezzanine



**Multiple Level Shelving
with Pick Unit Integration**



LYON[®]

PO Box 671, Aurora, IL 60507-0671
Sales Support: 800-323-0082
Fax: 800-367-6681
Email: lyon@lyonworkspace.com
www.lyonworkspace.com